

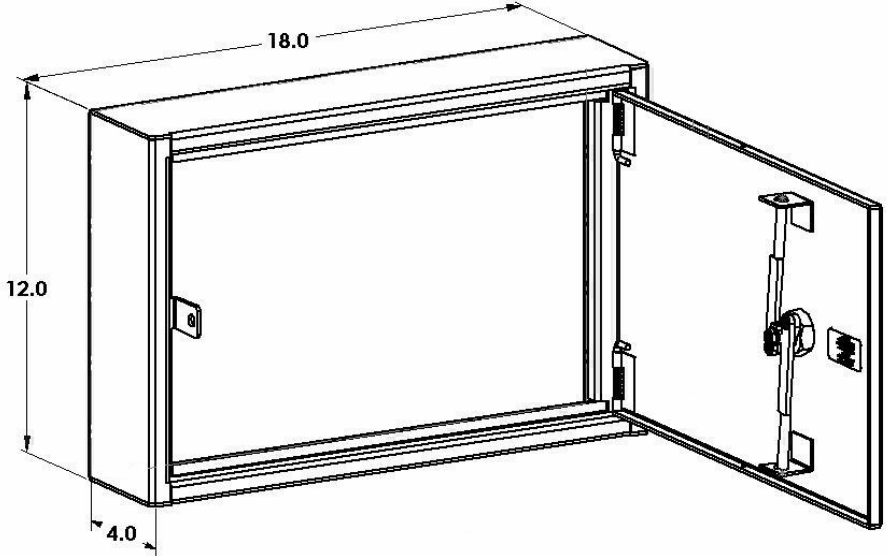

Product Code SEC-WM-PB1-H5	Nominal Dimensions 12" x 18" x 4"	
Description This 12-gauge High Security Pull Box enclosure mounts securely to walls and was designed to protect classified cabling and allow for the proper amount of cable loop within the enclosure. The door securely locks using Holocom's patented locking system and the Sargent and Greenleaf® padlock.		
Specifications <ul style="list-style-type: none"> • Height 12" x Width 18" x Depth 4" • 12-gauge electro-galvanized steel with welded seams • Weight: 24 lbs • Single door with 3-point security and padlock hasp • Tamper-resistant design with welded internal hinges Powder Coat Finish: White Textured		

	Holocom, Inc. 2386 Faraday Avenue, Suite 200 Carlsbad, CA 92008 Tel: (760) 804-9545 Fax: (760) 804-9149 www.holocom.com	PRODUCT CODE: SEC-WM-PB1-H5	TITLE: HIGH SECURITY PULL BOX
		All material contained in this document is the property of Holocom, Inc. and may not be reproduced or transmitted (including electronically) without the written consent of Holocom, Inc. Holocom and the Holocom logo are registered trademarks of Holocom, Inc. Other noted marks are trademarks of their respective companies. Holocom products protected by US Pats. 7,183,488; 7,115,814; 7,053,303; 7,049,517; 6,838,616; 5,831,211 and Pats. pending. Made in the U.S.A. Copyright © 2008 Holocom, Inc. All rights reserved.	